



*Unsere Ideen bewegen Menschen ...  
Our inventions move people ...*



**Pinnapyörät** | Spoked wheels

Valmistamme laajan valikoman erilaisia pinnapyöräkokonaisuuksia. Valittavana on magnesium-, alumiini- ja muovivanteet, rumpujarrut, desing-pyörät ja laaja valikoima tarvikkeita. Lisäksi valmistamme pyöriä erikoistarpeisiin.

Spoked wheels can be delivered in multitude accomplishments. Magnesium-, aluminium- and plastic rims, drum-brakes, design wheels and extensive accessories are at your disposal. Furthermore we produce wheels for your special use.

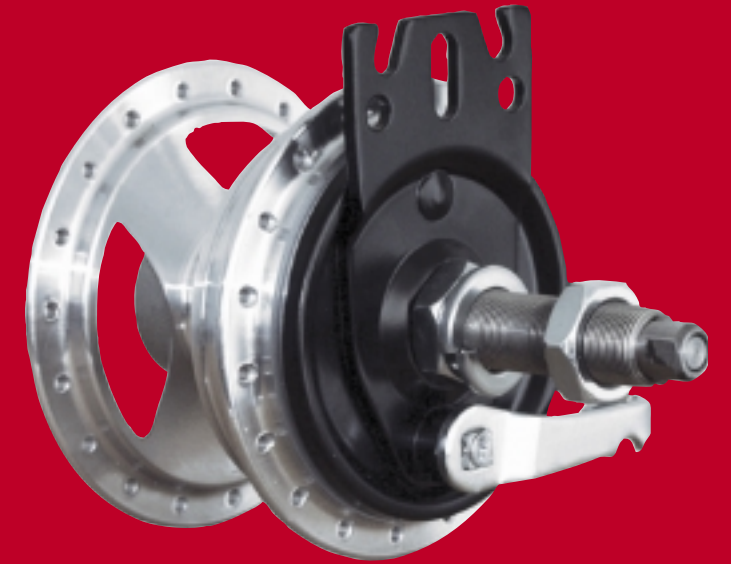

## Pinnapyörät | Spoked wheels 2006



Unsere Ideen bewegen Menschen ...  
Our inventions move people ...



### Sisältö | Content

- Pinnapyörät magnesium-vanteella** | Spoked wheels magnesium **4**
- Kelausvanteet SPIDER-pyöriin** | Push-rims for Spiderwheel **5**
- Pinnapyörät alumiinivanteella** | Spoked wheels aluminium **6**
- Pinnapyörät muovista** | Spoked wheels plastic **9**
- Pinnapyörät alumiinivanteella jarru** | Spoked wheels aluminium with brake **10**
- Navat** | Hubs **12**
- Kelausvanteet** | Push-rims **14**
- Kelausvanteensuojat** | Push-rim cover **16**
- Tarvikkeet** | Accessories **17**
- Pinnasuojat** | Spoke guards **18**



**Magesium-vanne** | Magnesium rim

**Korkeapaine ilmarengas** | High pressure pneumatic tyre  
**Alumiinikelausvanne, musta** | Push-rim in aluminium, black

| Tuuma<br>Inch |  |  |  | Art.-Nr<br>Art.-No   |
|---------------|---|---|--|----------------------|
| 24x1          | 12  | 50  | 6001   | R620/25-LMAG-GFA-L12 |
| 24x1          | 12  | 50  | 6001   | R620/25-LMAG-GFA-R12 |

**SPIDER magnesium-vanne** | Magnesium rim Spiderwheel

**Korkeapaine ilmarengas** | High pressure pneumatic tyre

| Tuuma<br>Inch |  |  |  | Väri<br>Colour  | Art.-Nr<br>Art.-No |
|---------------|---|---|--|-----------------|--------------------|
| 22x1          | 12  | 53  | 6001   | Sininen / blue  | R570/25-SPI-B      |
| 22x1          | 12  | 53  | 6001   | Punainen / red  | R570/25-SPI-R      |
| 22x1          | 12  | 53  | 6001   | Musta / black   | R570/25-SPI-S      |
| 22x1          | 12  | 53  | 6001   | Hopea / silver  | R570/25-SPI-SI     |
| 22x1          | 12  | 53  | 6001   | titangrau       | R570/25-SPI-TIG    |
| 24x1          | 12  | 53  | 6001   | Sininen / blue  | R620/25-SPI-B      |
| 24x1          | 12  | 53  | 6001   | Punainen / red  | R620/25-SPI-R      |
| 24x1          | 12  | 53  | 6001   | Musta / black   | R620/25-SPI-S      |
| 24x1          | 12  | 53  | 6001   | Hopeas / silver | R620/25-SPI-SI     |
| 24x1          | 12  | 53  | 6001   | titangrau       | R620/25-SPI-TIG    |
| 26x1          | 12  | 53  | 6001   | Musta / black   | R670/25-SPI-S      |

**Keulausvanteet sivulla 5** | Push-rim side 5

**Vaihtoehtona 1/2" laakerointi** | Optional ball bearing 1/2"

**Ruostumaton teräs, alumiini ja titaani kelausvanteet** | Push-rim in aluminium, titan, stainless st

| Tuuma<br>Inch | Kiinnitys<br>Bolt |       | Art.-Nr<br>Art.-No |
|---------------|-------------------|-------|--------------------|
| 22            | 5xM5              | Alu   | GF22-ALU-5         |
| 22            | 5xM5              | Titan | GF22-TITAN-5       |
| 22            | 5xM5              | RST   | GF22-VA-5          |
| 24            | 5xM5              | Alu   | GF24-ALU-5         |
| 24            | 5xM5              | Titan | GF24-TITAN-5       |
| 24            | 5xM5              | RST   | GF24-VA-5          |
| 26            | 5xM5              | Alu   | GF26-ALU-5         |
| 26            | 5xM5              | Titan | GF26-TITAN-5       |
| 26            | 5xM5              | RST   | GF26-VA-5          |

**Friktion S kelausvanteet** | Push-rim Friktion S

| Tuuma<br>Inch | Kiinnitys<br>Bolt |            | Art.-Nr<br>Art.-No |
|---------------|-------------------|------------|--------------------|
| 22            | 5xM5              | Friktion S | GF22-FRI-5         |
| 24            | 5xM5              | Friktion S | GF24-FRI-5         |
| 26            | 5xM5              | Friktion S | GF26-FRI-5         |

**Polymeeri „flat“ kelausvanteet**

| Push-rim Polymere, flat

| Tuuma<br>Inch | Kiinnitys<br>Bolt |          | Art.-Nr<br>Art.-No |
|---------------|-------------------|----------|--------------------|
| 22            | 5xM5              | Pehmeä   | GF22-PGF-5         |
| 22            | 5xM5              | Kompakti | GF22-PKF-5         |
| 24            | 5xM5              | Pehmeä   | GF24-PGF-5         |
| 24            | 5xM5              | Kompakti | GF24-PKF-5         |
| 26            | 5xM5              | Pehmeä   | GF26-PGF-5         |
| 26            | 5xM5              | Kompakti | GF26-PKF-5         |

**Polymeeri „round“ kelausvanteet**

| Push-rim Polymere, round

| Tuuma<br>Inch | Kiinnitys<br>Bolt |          | Art.-Nr<br>Art.-No |
|---------------|-------------------|----------|--------------------|
| 22            | 5xM5              | Pehmeä   | GF22-PGR-5         |
| 22            | 5xM5              | Kompakti | GF22-PKR-5         |
| 24            | 5xM5              | Pehmeä   | GF24-PGR-5         |
| 24            | 5xM5              | Kompakti | GF24-PKR-5         |
| 26            | 5xM5              | Pehmeä   | GF26-PGR-5         |
| 26            | 5xM5              | Kompakti | GF26-PKR-5         |





**Tuplapohjavanne** | Double wall rim

**Korkeapaine ilmarengas** | High pressure pneumatic tyre  
**Alumiininapa, iso laippa** | Aluminium hub high flange  
**Alumiinikelausvanne** | Push-rim in aluminium

| Tuuma<br>Inch |    |    |      | Art.-Nr<br>Art.-No |
|---------------|----|----|------|--------------------|
| 24x1          | 12 | 53 | 6001 | R620/25-LADTH-GFA  |



**Tuplapohjavanne** | Double wall rim

**Korkeapaine ilmarengas** | High pressure pneumatic tyre  
**Alumiininapa, suora pinnaus** | Aluminium hub with straight spokes  
**Alumiinikelausvanne** | Push-rim in aluminium

| Tuuma<br>Inch |    |    |      | Art.-Nr<br>Art.-No |
|---------------|----|----|------|--------------------|
| 24x1          | 12 | 48 | 6001 | R620/25-LADTSP-GFA |

**Vaihtoehtona 1/2" laakerointi** | Optional ball bearing 1/2"

**Tuplapohjavanne** | Double wall rim

**Korkeapaine ilmarengas** | High pressure pneumatic tyre  
**Alumiini design- napa, erikoispinnoin** | Aluminium design hub with spezial spokes  
**Alumiinikelausvanne** | Push-rim in aluminium

| Tuuma<br>Inch |    |      |                   | Art.-Nr<br>Art.-No |
|---------------|----|------|-------------------|--------------------|
| 24            | 12 | 6001 | R620/25-LEH4R-GFA |                    |
| 26-559        | 12 | 6001 | R650/25-LEH4R-GFA |                    |
| 26-590        | 12 | 6001 | R670/25-LEH4R-GFA |                    |



**Tuplapohjavanne** | Aluminium rim

**Korkeapaine ilmarengas** | High pressure pneumatic tyre  
**Alumiininapa** | Aluminium hub  
**Alumiinikelausvanne** | Push-rim in aluminium

| Tuuma<br>Inch |    |    |      | Art.-Nr<br>Art.-No |
|---------------|----|----|------|--------------------|
| 22x1          | 12 | 53 | 6001 | R570/25-LAS-GFA    |
| 22x1.3/8      | 12 | 53 | 6001 | R570/35-LAS-GFA    |
| 24x1          | 12 | 53 | 6001 | R620/25-LAS-GFA    |
| 24x1.3/8      | 12 | 53 | 6001 | R620/35-LAS-GFA    |
| 26x1          | 12 | 53 | 6001 | R670/25-LAS-GFA    |
| 26x1.3/8      | 12 | 53 | 6001 | R670/35-LAS-GFA    |



**Vaihtoehtona 1/2" laakerointi** | Optional ball bearing 1/2"



**Alumiinivanne** | Aluminium rim

**Ilmarengas** | Pneumatic tyre

**Alumiininapa** | Aluminium hub

**Kromattu teräskelausvanne** | Push-rim in steel

| Tuuma<br>Inch |      |    |      | Art.-Nr<br>Art.-No |
|---------------|------|----|------|--------------------|
| 20x1          | 12,0 | 53 | 6001 | R510/25-LA-GF      |
| 20x1.3/8      | 12,0 | 53 | 6001 | R510/35-LA-GF      |
| 22x1          | 12,0 | 53 | 6001 | R570/25-LA-GF      |
| 22x1.3/8      | 12,0 | 53 | 6001 | R570/35-LA-GF      |
| 24x1          | 12,0 | 53 | 6001 | R620/25-LA-GF      |
| 24x1.3/8      | 12,0 | 53 | 6001 | R620/35-LA-GF      |
| 26x1          | 12,0 | 53 | 6001 | R670/25-LA-GF      |
| 26x1.3/8      | 12,0 | 53 | 6001 | R670/35-LA-GF      |



**Alumiinivanne** | Aluminium rim

**Ilmarengas** | Pneumatic tyre

**Alumiininapa** | Aluminium hub

**Alumiinikelausvanne** | Push-rim in aluminium

| Tuuma<br>Inch |      |    |      | Art.-Nr<br>Art.-No |
|---------------|------|----|------|--------------------|
| 24x1.90       | 12,0 | 53 | 6001 | R620/50-LA-GFA     |

**Vaihtoehtona 1/2" laakerointi** | Optional ball bearing 1/2"

**Muovivanne** | Plastic rim

**Ilmarengas** | Pneumatic tyre

**Muovikelausvanne** | Push-rim in plastic

| Tuuma<br>Inch |    |    |        | Art.-Nr<br>Art.-No |
|---------------|----|----|--------|--------------------|
| 24x1.3/8      | 12 | 50 | 6201   | R620/35-L-GF       |
| 24x1.3/8      | 12 | 50 | 6201VA | R620/35-L-GF-VA    |

**VA = Metalliosat ruostumatonta terästä** | Accomplishment stainless



**Muovivanne** | Plastic rim

**Ilmarengas** | Pneumatic tyre

**Muovikelausvanne** | Push-rim in plastic

**Rumpujarru** | Drum-brake

| Tuuma<br>Inch |    |    | Kiinnitys<br>Bolt | Art.-Nr<br>Art.-No |
|---------------|----|----|-------------------|--------------------|
| 24x1.3/8      | 12 | 43 | M12x100           | R620/35-L-GFBL     |
| 24x1.3/8      | 12 | 43 | M12x100           | R620/35-L-GFBR     |

**BL= jarru vasemmalla** | Left side

**BR= jarru oikealla** | Right side





**Tuplapohjavanne** | Double wall rim

**Korkeapaine ilmarengas** | High pressure pneumatic tyre  
**Alumiininapa levyjarrulla** | Aluminium hub with disc-brake  
**Alumiinikelausvanne** | Push-rim in aluminium

| Tuuma<br>Inch |    |    |      | Art.-Nr<br>Art.-No |
|---------------|----|----|------|--------------------|
| 24x1          | 12 | 68 | 6001 | R620/25-LHSD-GFA   |
| 24x1.3/8      | 12 | 68 | 6001 | R620/35-LHSD-GFA   |
| 26x1          | 12 | 68 | 6001 | R670/25-LHSD-GFA   |
| 26x1.3/8      | 12 | 68 | 6001 | R670/35-LHSD-GFA   |



**NA-D36-12**

**Alumiininapa levyjarrua varten**  
 | Aluminium hub for brake disc



**U-D160-1**

**Levyjarru** | Brake disc



**U-BB-WZ1-R = oikea** | Right  
**U-BB-WZ1-L = vasen** | Left

**Jarrusatula** | Calliper



**Alumiinivanne** | Aluminium rim

**Ilmarengas** | Pneumatic tyre  
**Alumiininapa rumpujarrulla** | Drum-brake hub aluminium  
**Akseli** | Axle M12 x 150 mm  
**Kromattu teräskelausvanne** | Push-rim in steel chromed

| Tuuma<br>Inch |    |    |      | Art.-Nr<br>Art.-No |
|---------------|----|----|------|--------------------|
| 20x1.3/8      | 12 | 77 | 6001 | R510/35-LA-GFBL    |
| 20x1.3/8      | 12 | 77 | 6001 | R510/35-LA-GFBR    |
| 22x1.3/8      | 12 | 77 | 6001 | R570/35-LA-GFBL    |
| 22x1.3/8      | 12 | 77 | 6001 | R570/35-LA-GFBR    |
| 24x1.3/8      | 12 | 77 | 6001 | R620/35-LA-GFBL    |
| 24x1.3/8      | 12 | 77 | 6001 | R620/35-LA-GFBR    |
| 26x1.3/8      | 12 | 77 | 6001 | R670/35-LA-GFBL    |
| 26x1.3/8      | 12 | 77 | 6001 | R670/35-LA-GFBR    |

**BL= jarru vasemmalla** | Left side  
**BR= jarru oikealla** | Right side



**Alumiinivanne** | Aluminium rim

**Ilmarengas** | Pneumatic tyre  
**Alumiininapa rumpujarrulla** | Drum-brake hub aluminium  
**Pikalukitusakseli** | Quick-Release-Axle 12 x 123 mm  
**Kromattu teräskelausvanne** | Push-rim in steel chromed

| Tuuma<br>Inch |    |      |      | Art.-Nr<br>Art.-No |
|---------------|----|------|------|--------------------|
| 20x1.3/8      | 12 | 71,5 | 6001 | R510/35-LAGFBLQ    |
| 20x1.3/8      | 12 | 71,5 | 6001 | R510/35-LAGFBRQ    |
| 22x1.3/8      | 12 | 71,5 | 6001 | R570/35-LAGFBLQ    |
| 22x1.3/8      | 12 | 71,5 | 6001 | R570/35-LAGFBRQ    |
| 24x1.3/8      | 12 | 71,5 | 6001 | R620/35-LAGFBLQ    |
| 24x1.3/8      | 12 | 71,5 | 6001 | R620/35-LAGFBRQ    |
| 26x1.3/8      | 12 | 71,5 | 6001 | R670/35-LAGFBLQ    |
| 26x1.3/8      | 12 | 71,5 | 6001 | R670/35-LAGFBRQ    |

**LQ = jarru vasemmalla** | Left side  
**RQ = jarru oikealla** | Right side





**DT napa „Single Stop“**

| DT hub Single Stop





**DT Single Stop on pysäköintijarrulla varustettu uudenlainen napa pyörätuoliin. Paras etu tästä uudeltaisesta järjestelmästä on se, että jarrukahava voidaan asentaa pyörätuolissa sinne missä se parhaiten palvelee pyörätuolin käyttäjää.**

|    |  |  | Pinnat Spokes | Art.-Nr Art.-No |
|----|---|---|---------------|-----------------|
| 48 | 12  | 24  |               | NA-24-STOP-S    |
| 48 | 12  | 36  |               | NA-36-STOP-S    |

**Aktiivinen urheilullinen pyörätuolinkäyttäjä löytää täydellisen navan joka lähtöön DT Swiss- napa valikoimasta. Laaja valikoima kevyitä DT regular-napoja tai DT-single stop integroidulla jarrulla jokapäiväiseen käyttöön.**



**DT isolaippainen napa | DT high flange hub**

|    |  |  | Pinnat Spokes | Art.-Nr Art.-No |
|----|---|---|---------------|-----------------|
| 53 | 12  | 24  |               | NA-H24-S        |
| 53 | 12  | 36  |               | NA-H36-S        |

**DT napa suorapinnaukselle**

| DT hub Straight Pull





|    |  |  | Pinnat Spokes | Art.-Nr Art.-No |
|----|---|---|---------------|-----------------|
| 48 | 12  | 24  |               | NA-24-DTRSP-S   |

**DT regular napa**

| DT hub regular





|    |  |  | Pinnat Spokes | Art.-Nr Art.-No |
|----|--|---|---------------|-----------------|
| 48 | 12   | 24  |               | NA-24-DTR-S     |

**Nerokas lukitusjärjestelmä takaa varman pitävyyden pyörästä. Pyörätuoli pysyy paikoillaan joka tilanteessa riippumatta rengaspaineesta, sääolosuhteista, käyttäjän painosta tai tason kaltevuudesta. Asennus ja käyttö ovat helppoja, ei ylimääräisiä vaijereita, ei lisää jarrukahvoja tai jatkuvaa jarrujen säätämistä.**



DT single stop is a high quality wheelchair hub with a new kind of locking brake. The advantage of this system is that the actuation lever can be positioned anywhere on the wheelchair – according to the needs of the wheelchair rider. The ingenious locking system ensures tight locking of the wheel. The wheelchair is kept safe in any situation – regardless of tire pressure, weather conditions, body weight and incline! Mounting is very simple and no Bowden cables, additional actuating levers or special adjustment work are required!

The active, athletic wheelchair user will find the perfect hub for every use in the DT Swiss wheelchair hub range – the light DT regular hubs in a wide range of designs or the DT single stop with the integrated brake for everyday use



**Alumiini napa | Aluminium hub****Hopea | Silver**

|  |  | Pinnat Spokes | Art.-Nr Art.-No |
|---|---|---------------|-----------------|
| 53  | 12  | 36            | NA-36-12        |



**Musta | Black**

|  |  | Pinnat Spokes | Art.-Nr Art.-No |
|---|---|---------------|-----------------|
| 53  | 12  | 36            | NA-36-12S       |

**Alumiininapa rumpujarrulla | Drum-brake hub aluminium****Akseli | Axle M12 x 150 mm**

|  |  | Pinnat Spokes | Art.-Nr Art.-No |
|---|---|---------------|-----------------|
| 77  | 12  | 36            | NA-Top-BL       |
| 77  | 12  | 36            | NA-Top-BR       |

**BL= jarru vasemmalla | Left side****BR= jarru oikealla | Right side****Alumiininapa rumpujarrulla | Drum-brake hub aluminium****Pikalukitusakseli | Quick-Release-Axle 12 x 123 mm**

|  |  | Pinnat Spokes | Art.-Nr Art.-No |
|---|---|---------------|-----------------|
| 71,5  | 12  | 36            | NA-Top-BLQ-123  |
| 71,5  | 12  | 36            | NA-Top-BRQ-123  |

**LQ = jarru vasemmalla | Left side****RQ = jarru oikealla | Right side**



**Kromattu teräskelausvanne**

| Push-rim in steel, chromed

| Tuuma<br>Inch | D   | D1 | Kiinnitys<br>Bolt | Art.-Nr<br>Art.-No |
|---------------|-----|----|-------------------|--------------------|
| 20            | 416 | 20 | 4xM5              | GF20-CHR           |
| 22            | 455 | 20 | 4xM5              | GF22-CHR           |
| 24            | 505 | 20 | 4xM5              | GF24-CHR           |
| 26            | 555 | 20 | 4xM5              | GF26-CHR           |



**Kromattu teräskelausvanne**

| Push-rim in steel, chromed

| Tuuma<br>Inch | D   | D1 | Latta<br>Straps | Art.-Nr<br>Art.-No |
|---------------|-----|----|-----------------|--------------------|
| 24            | 520 | 20 | 4               | GF24-CHR-4L        |
| 24            | 520 | 20 | 6               | GF24-CHR-6L        |



**Alumiinikelausvanne** | Push-rim in aluminium

| Tuuma<br>Inch | D   | D1 | Latta<br>Straps | Art.-Nr<br>Art.-No |
|---------------|-----|----|-----------------|--------------------|
| 20            | 445 | 20 | 4               | GF20-Alu-4L        |
| 22            | 470 | 20 | 4               | GF22-Alu-4L        |
| 24            | 520 | 20 | 6               | GF24-AS-6L         |
| 26-590        | 574 | 20 | 6               | GF26-AS-6L         |
| 26-559        | 537 | 20 | 6               | GF26-AS-6L-537     |
| 28            | 607 | 20 | 6               | GF28-AS-6L         |



**Ruostumaton teräskelausvanne**

| Push-rim in stainless steel

| Tuuma<br>Inch | D   | D1 | Latta<br>Straps | Art.-Nr<br>Art.-No |
|---------------|-----|----|-----------------|--------------------|
| 22            | 470 | 20 | 4               | GF22-V2A-4L        |
| 24            | 520 | 20 | 6               | GF24-V2A-6L        |
| 26            | 568 | 20 | 6               | GF26-VA-6L         |

**GF24-AS-SOFT**

**Alumiinikelausvanne SOFT-pinnalla**

| Push-rim in aluminium with soft cover

| Tuuma<br>Inch | D   | D1 | Latta<br>Straps | Art.-Nr<br>Art.-No |
|---------------|-----|----|-----------------|--------------------|
| 22            | 470 | 26 | 4               | GF22-AS-SOFT       |
| 24            | 520 | 26 | 6               | GF24-AS-SOFT       |
| 26            | 570 | 26 | 6               | GF26-AS-SOFT       |



**Ovaali muovikelausvanne** | Push-rim in plastic oval

| Tuuma<br>Inch | D   | D1    | Kiinnitys<br>Bolt | Art.-Nr<br>Art.-No |
|---------------|-----|-------|-------------------|--------------------|
| 20            | 416 | 20/25 | 4xM5              | GF-K-O-20          |
| 22            | 455 | 20/25 | 4xM5              | GF-K-O-22          |
| 22            | 455 | 20/25 | 6xM5              | GF-K-O-22-6        |
| 24            | 505 | 20/25 | 4xM5              | GF-K-O-24          |
| 24            | 505 | 20/25 | 6xM5              | GF-K-O-24-6        |



| Tuuma<br>Inch | D   | D1    | Kiinnitys<br>Bolt | Art.-Nr<br>Art.-No |
|---------------|-----|-------|-------------------|--------------------|
| 20            | 416 | 20/25 | 4x8               | GF-K-O-20-4-REV    |
| 22            | 455 | 20/25 | 6x8               | GF-K-O-22-6-REV    |
| 24            | 505 | 20/25 | 6x8               | GF-K-O-24-6-REV    |



**Kiinnitysjärjestelmät kelusvanteisiin** | Fixation for push-rims



| Art.-Nr<br>Art.-No |
|--------------------|
| 4 x M5 U-BEF-GR-4  |
| 6 x M5 U-BEF-GR-6  |



| Art.-Nr<br>Art.-No |
|--------------------|
| 8 U-BEF-KU-GR      |

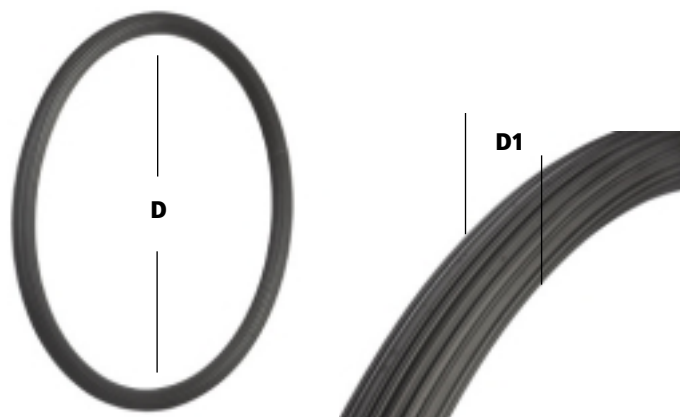

**Silikoni kelausvanteen suojat** | Push-rim cover in silicone

**Musta uritettu** | Black fluted

| Tuuma<br>Inch | D       | D1    | Art.-Nr<br>Art.-No |
|---------------|---------|-------|--------------------|
| 20            | 412-424 | 16-21 | SGR-20             |
| 22            | 486-501 | 16-21 | SGR-22             |
| 24            | 519-532 | 16-21 | SGR-24             |
| 26            | 571-590 | 16-21 | SGR-26             |

**Silikoni kelausvanteen suojat** | Push-rim cover in silicone

**Musta sileä** | Black smooth

| Tuuma<br>Inch | D       | D1    | Art.-Nr<br>Art.-No |
|---------------|---------|-------|--------------------|
| 20            | 412-424 | 16-21 | SGR-20-G           |
| 22            | 486-501 | 16-21 | SGR-22-G           |
| 24            | 519-532 | 16-21 | SGR-24-G           |
| 26            | 571-590 | 16-21 | SGR-26-G           |

**Silikoni kelausvanteen suojat** | Push-rim cover in silicone

**Harmaa sileä** | Grey smooth

| Tuuma<br>Inch | D       | D1    | Art.-Nr<br>Art.-No |
|---------------|---------|-------|--------------------|
| 20            | 412-424 | 16-21 | SGR-20-GRAU-G      |
| 22            | 486-501 | 16-21 | SGR-22-GRAU-G      |
| 24            | 519-532 | 16-21 | SGR-24-GRAU-G      |
| 26            | 571-590 | 16-21 | SGR-26-GRAU-G      |

**Pikalukitusakselit** | Quick-release axle

| EL  | D    | Art.-Nr<br>Art.-No |
|-----|------|--------------------|
| 85  | 12   | QRA-85             |
| 98  | 12   | QRA-98             |
| 103 | 12   | QRA-103            |
| 104 | 1/2" | QRA-104-1/2        |
| 108 | 12   | QRA-108            |
| 123 | 12   | QRA-123            |
| 123 | 1/2" | QRA-123-1/2        |

**Kokonaan ruostumattomasta teräksestä valmistettu tuote**  
| Accomplishment completely stainless steel

| EL  | D    | Art.-Nr<br>Art.-No |
|-----|------|--------------------|
| 98  | 12   | QRA-98-KVA         |
| 103 | 12   | QRA-103-KVA        |
| 104 | 1/2" | QRA-104-1/2-KVA    |
| 123 | 12   | QRA-123-KVA        |

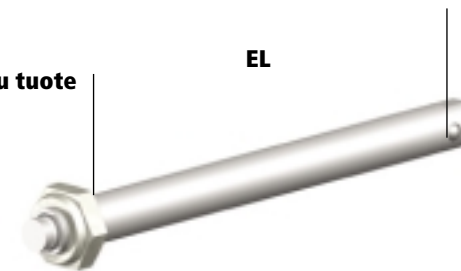

**Pikalukitusakselit** | Quick release axle

| EL  | D  | Art.-Nr<br>Art.-No |
|-----|----|--------------------|
| 78  | 12 | QRA-78-VA-K28      |
| 98  | 12 | QRA-98-VA-K32      |
| 103 | 12 | QRA-103-VA-K28     |



**Adapteri** | Adapter

**2 x M16 mutteri ja jousialuslevy** | 2 x nut M16 and spring washer

| L  | L2 | D    | Art.-Nr<br>Art.-No |
|----|----|------|--------------------|
| 51 | 9  | 1/2" | A12-51-9           |
| 45 | 7  | 12   | A12-45-7           |
| 50 | 10 | 12   | A12-50-10          |
| 57 | 13 | 12   | A12-57-13          |
| 72 | 13 | 12   | A12-72-13          |
| 74 | 10 | 12   | A12-74-10          |

**Kokonaan ruostumattomasta teräksestä valmistettu tuote**  
| Accomplishment stainless steel

| L  | L2 | D  | Art.-Nr<br>Art.-No |
|----|----|----|--------------------|
| 31 | 9  | 12 | A12-31-9-VA        |
| 50 | 10 | 12 | A12-50-10-VA       |

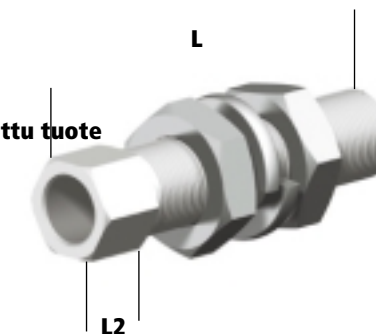

**Kurakaari** | Wheel cover

**Yleismalli** | Universal

| Tuuma<br>Inch | L   | B  | H   | Art.-Nr<br>Art.-No |
|---------------|-----|----|-----|--------------------|
| 24 universal  | 460 | 48 | 100 | RA460/48-S         |

| Tuuma<br>Inch | L   | B  | H   | Art.-Nr<br>Art.-No |
|---------------|-----|----|-----|--------------------|
| 12.1/2x2.1/4  | 320 | 60 | 160 | RA310/55-S         |
| 20x1.3/8      | 545 | 60 | 220 | RA510/35-S         |
| 22x1.3/8      | 590 | 60 | 250 | RA570/35-S         |
| 24x1.3/8      | 640 | 60 | 280 | RA620/35-S         |



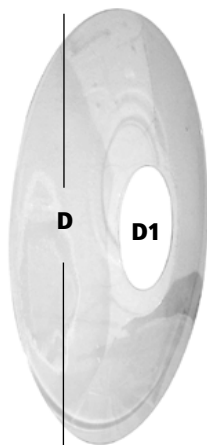

**Materiaali PET 1 mm | Material PET 1 mm**

**Kirkas | Transparency**

**Toimitus sisältää kiinnitys tarvikkeet | Including fixing**

| Tuuma<br>Inch | D   | D1  | Art.-Nr<br>Art.-No |
|---------------|-----|-----|--------------------|
| 20x1.75       | 385 | 137 | SP-TR-20x1.75      |
| 22x1.3/8      | 443 | 135 | SP-TR-570          |
| 24x1.3/8      | 485 | 138 | SP-TR-620          |

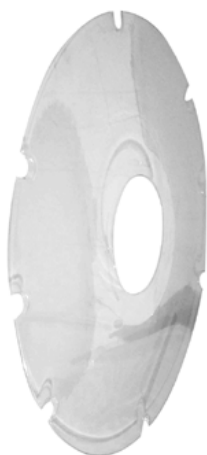

**Materiaali PET 1 mm | Material PET 1 mm**

**Kirkas | Transparency**

**Toimitus sisältää kiinnitys tarvikkeet | Including fixing screws**

| Tuuma<br>Inch | D   | D1  | Art.-Nr<br>Art.-No |
|---------------|-----|-----|--------------------|
| 20x1.3/8      | 431 | 135 | SP-TR-510L4        |
| 22x1.3/8      | 469 | 135 | SP-TR-570L4/6      |
| 24x1.3/8      | 512 | 142 | SP-TR-620L4/6      |
| 26x1.3/8      | 564 | 138 | SP-TR-670L4/6      |

**Materiaali PET 1,5 mm | Material PET 1,5 mm**

**Kirkas | Transparency**

**Reiät kiinnitystä varten | With drillings for fixation**

| Tuuma<br>Inch | D   | D1  | Art.-Nr<br>Art.-No |
|---------------|-----|-----|--------------------|
| 24x1.3/8      | 512 | 142 | SP-TR-620-1        |



**Standardi kiinnitys | Standard fastening**



**Vaihtoehtoinen kiinnitys | Optional with straps**

**Pinnasuoja tarrat | Spoke guard motives**



SKF-SP-570-1



SKF-SP-570-2



SKF-SP-620-1



SKF-SP-620-2

**Laajempi valikoima eri rangasvaihtoehtoja luettelossa 5 | A multitude of tyre possibilities are available see chapter 5 tyres**



**Ilmarenkaat | Pneumatic tyre**



**Polyuretaanirenkaat | Polyurethane tyre**

**Kaikki mitat ovat likiarvoja.**

**Kuvat eivät ole sitovia. Muutokset mahdollisia.**

**Toimitukset toimitusehtojemme mukaisesti.**

All measures are approx. informations.

Illustrations are not binding. Changings possible.

We deliver as our latest general delivery conditions.



*Unsere Ideen bewegen Menschen ...  
Our inventions move people ...*



**Germany**

**Rolko Kohlgrüber GmbH**  
Industriestraße 14  
D-33829 Borgholzhausen

Phone +49 5425 9402-0  
Fax +49 5425 9402-20

[www.rolko.com](http://www.rolko.com)  
[info@rolko.com](mailto:info@rolko.com)

**Danmark**

**Rolko Scandinavia ApS**  
Suensonvej 2  
DK-8600 Silkeborg

Phone +45 87 20 18 88  
Fax +45 86 81 86 88

[www.rolko.com](http://www.rolko.com)  
[RolkoDK@rolko.com](mailto:RolkoDK@rolko.com)

**Netherlands**

**Rolko Nederland bv**  
Limburghaven 2b  
NL-3433 PK Nieuwegein

Phone +313 02 41 32 30  
Fax +313 02 54 16 55

[www.rolko.com](http://www.rolko.com)  
[RolkoNL@rolko.com](mailto:RolkoNL@rolko.com)

**Poland**

**Rolko Polska Sp.z.o.o.**  
ul. Paderewskiego 3 b  
PL-59400 Jawor

Phone +48 76 870 70 70  
Fax +48 76 870 70 20

[www.rolko.com](http://www.rolko.com)  
[RolkoPL@rolko.com](mailto:RolkoPL@rolko.com)

**Finland**

**Tradotim Oy**  
Raamikatu 1  
FI-38200 Vammala

Phone +358 3 5128 500  
Fax +358 3 5128 515

[www.tradotim.fi](http://www.tradotim.fi)  
[info@tradotim.fi](mailto:info@tradotim.fi)